



THINK COMPACT EDGE EASY

— ProWoodTech —



E450 PM

Automatic edge bander with holt- melt glue pot (EVA), chain panel - feeding and pre-milling



Site



E450 PM



YouTube

E450 PM

Automatic edge bander with hot- melt glue pot (EVA), chain panel - feeding and pre-milling



ProWoodTech



Professional finishing quality in only 2,30 metres length.

- Maximum finishing quality
 - ✓ Chain feeding system
 - ✓ Pre-milling
 - ✓ Interchangeable glueing unit Flex (opt.)
 - ✓ 2 spaces for finishing units
- High performance
 - ✓ 7 m/min feed speed
 - ✓ 45 mm panel height
 - ✓ 3 mm edge coils
- Minimum space occupied ✓ 2,30 m
- Easy to use
 - ✓ unit settings with a piece of edge
 - ✓ easy and intuitive use of machine

■ Pre-milling unit with 2 HF motors and 2 diamond cutterblocks to obtain an invisible glueing line

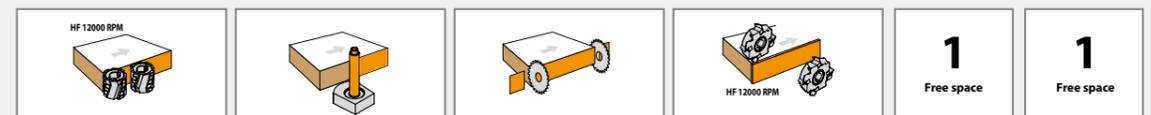

THINK COMPACT EDGE EASY

E450 PM



Pre-milling unit

INVISIBLE GLUEING LINE

- DIAMOND tools
Ø = 60 mm H = 52 mm
- HF motors 200 Hz - 12.000 rpm
- 0.75 kW (each)
- Dedicated suction system and blower for panel cleaning before glueing

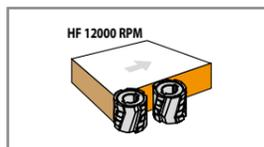

End Trimming unit

PERFORMANCE AND VERSATILITY

- 2 blades for perfect front/rear end trimming on all types of edges.
- Operating cycle controlled by PLC.
- Blade rotation speed - 12.000 rpm
- Integrated suction system.

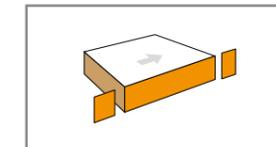

Glueing unit

PERFECT GLUEING, QUICK AND PRACTICAL SET-UPS

- 6 heating elements to guarantee uniform glue temperature.
- Motorized glue spreading roller with an internal electrical heating element.
- Teflon-coated glue pot to permit complete and rapid cleaning.

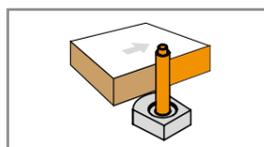

Flush Trimming units (Std)

THREE PROCESSES

- Rapid changeovers working between radius milling, thin and solid edges.
- The system "reads" the edge thickness, making mistakes impossible!
- 2 HF motors 200 Hz - 12,000 rpm - 0.37 kW

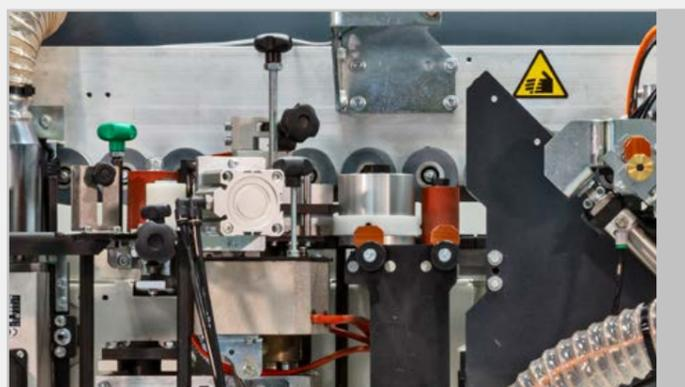
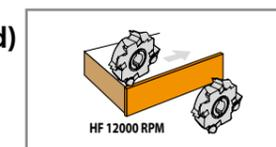

Pneumatic shear, pressure rollers, edge feeding system

DETAILS THAT MAKE THE DIFFERENCE

- Edge feeding synchronized with panel being processed
- Oscillatory movement of the cutting shear unit to guarantee perfect glueing
- Quick and precise positioning of the pressure rollers. The system "reads" the edge thickness, making mistakes impossible!



Work Set ups

ERGONOMICS, PRECISION AND RELIABILITY

- Handy pendant Control panel

E450 PM

THINK COMPACT EDGE EASY



TOUCHME Work Set ups

ERGONOMICS, PRECISION AND RELIABILITY



Touchscreen control Easy to use, Intuitive and Immediate

- 7" Colour display
- Save n° 99 working programmes
- Impossible to go wrong; the graphic visualizes directly the result of the process on the edged panel
- Just one click to choose the desired workmanship

Interchangeable glueing unit "Flex"

MAXIMUM FLEXIBILITY



- Quick release device for fast and easy replacement of the glue pot
- Interchangeable glueing pot Teflon-coated to permit complete and rapid cleaning
- Glue pot capacity 1 kg
- Thermal regulation settable on two different temperatures based on the type of glue used
- Automatic standby during the work breaks

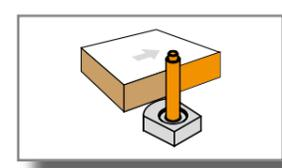

Anti-adherence / release agent spraying unit



INSTANT PERFECT CLEANING

- Spray function controlled by PLC
- 2 sprayers (lower and upper) and liquid tank

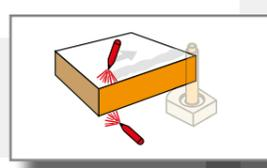

Infrared lamp

TO GUARANTEE THE BEST GLUEING CONDITIONS

- Creates the best conditions for perfect glueing.
- Heats panels and removes all traces of dampness.

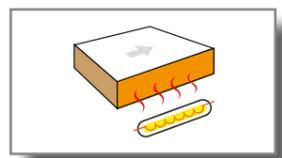

Internal LED light

ALL UNITS UNDER CONTROL

- The internal led lights on the units allows to make adjustments in safety, even with bad outside lighting



VR or VS end trimming group with vertical rounding or bevel function

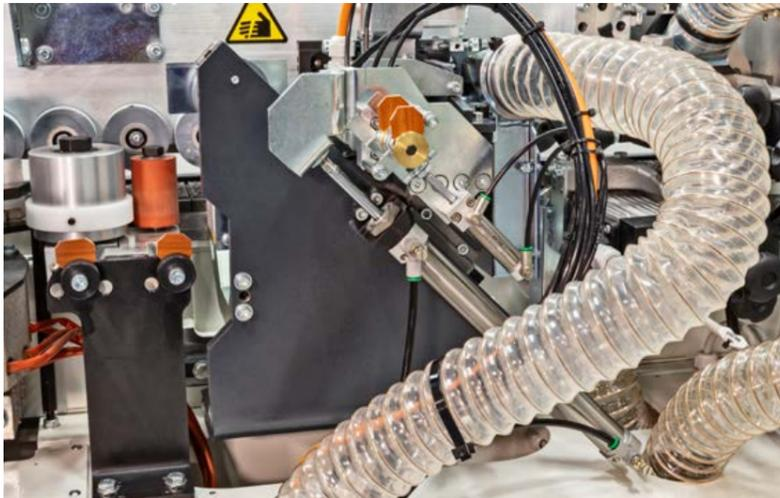

- VR or VS end trimming group to remove and mill edge excess on front/rear side of the panel
- 2 processing modes:
 - "VR" radius (ABS and PVC thick edges) straight (thin edges and wooden strips) - or
 - "VS" bevel (thin edges) straight (thin edges and wooden strips)
- Unit managed by the electronic control with the possibility to specifically choose the processing mode for the front and the rear of the panel

■ High frequency motor 0,22kW - 12.000 RPM

■ Integrated dust extraction system that includes the la extractor hood of the wood chips and flexible hose for connection to the external port D=120mm



Cleaning spray agent unit



MIRROR FINISHING

- Spray function controlled by PLC.
- 2 sprayers (lower and upper) and liquid tank.

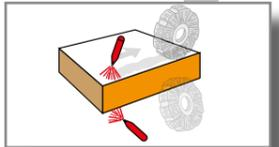

Glue Scraping unit

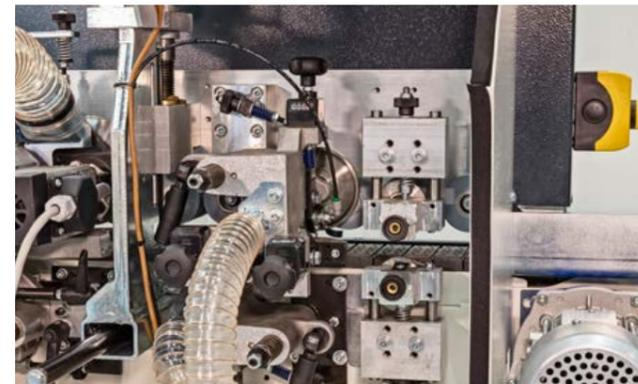

REMOVAL OF EXCESS GLUE

- Copier discs with automatic cleaning system.
- Two separate knobs which allow an easy positioning of the tool and a fast exclusion of the unit.

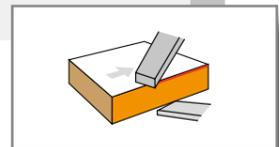

Edge scraping unit

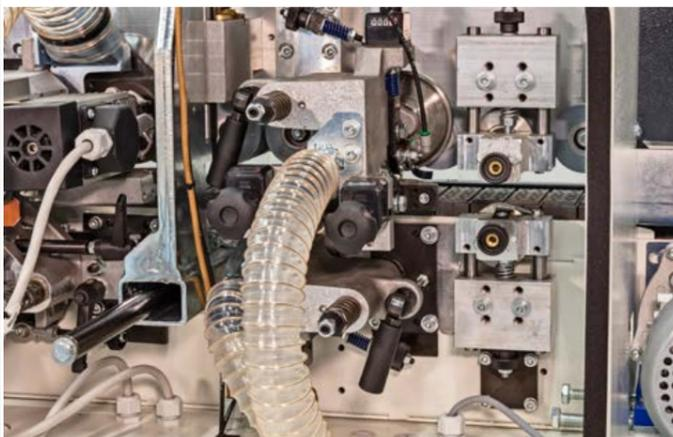

PERFECT PLASTIC EDGES EVEN IN BACKLIGHT

- Blowers for detachment and removal of shavings.
- Dust extraction system complete with box to separate and collect edge scraping shavings.

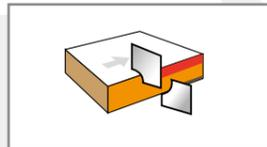

Buffing unit

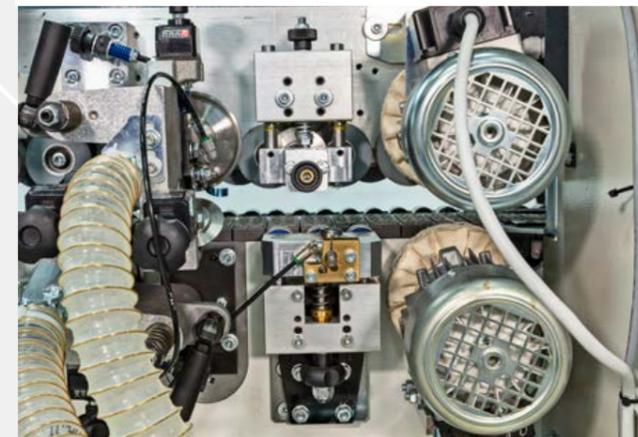

BRIGHT AND SHINY EDGES

- Uniform colouring even on processed edges.
- Panel cleaning
- 2 motors rotating at 1.400 rpm.
- 2 brushes diameter 120 mm

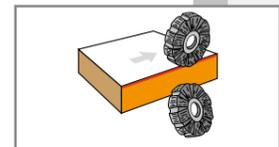



Technical features

Min./max. panel height	min 8 - max 45 mm
Min./max. edge thickness	0,4 - 3 mm (coils) / 0,4 - 5 mm (strips)*
Minimum panel width	95 mm
Minimum panel length (side being processed)	210 mm
Panel feed speed	7 m/min
Pre-milling motors (each)	200 Hz - 12.000 rpm - 0,75 kW
Glue pot heating element	1490 W - Nr. 6 cartridges
End trimming blade rotation speed	9000 rpm
End trimming motor	50 Hz - 0,18 kW
Flush trimming motors (each)	200 Hz - 12.000 rpm - 0,22 kW
Cutterblocks with combined WIDIA disposable Knives (radius/bevelled)	Ø 75 mm Z4 - hole Ø 16 mm
Total power installed	5 kW approx.
Weight	420 Kg approx.

* the maximum thickness of the strip depends on wood hardness

Compositions

THINK COMPACT EDGE EASY

■ E450 PM

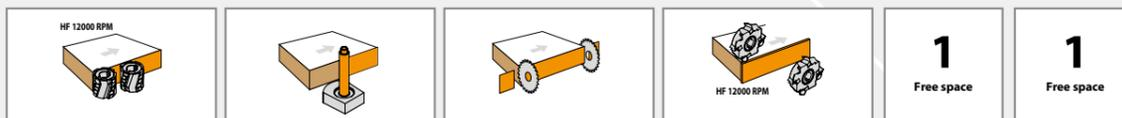

■ Optionals for free spaces (on the machine there are 2 free spaces for the installation of the following optional groups)

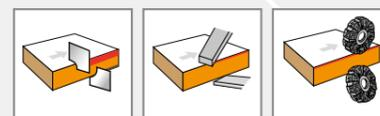

Overall dimensions

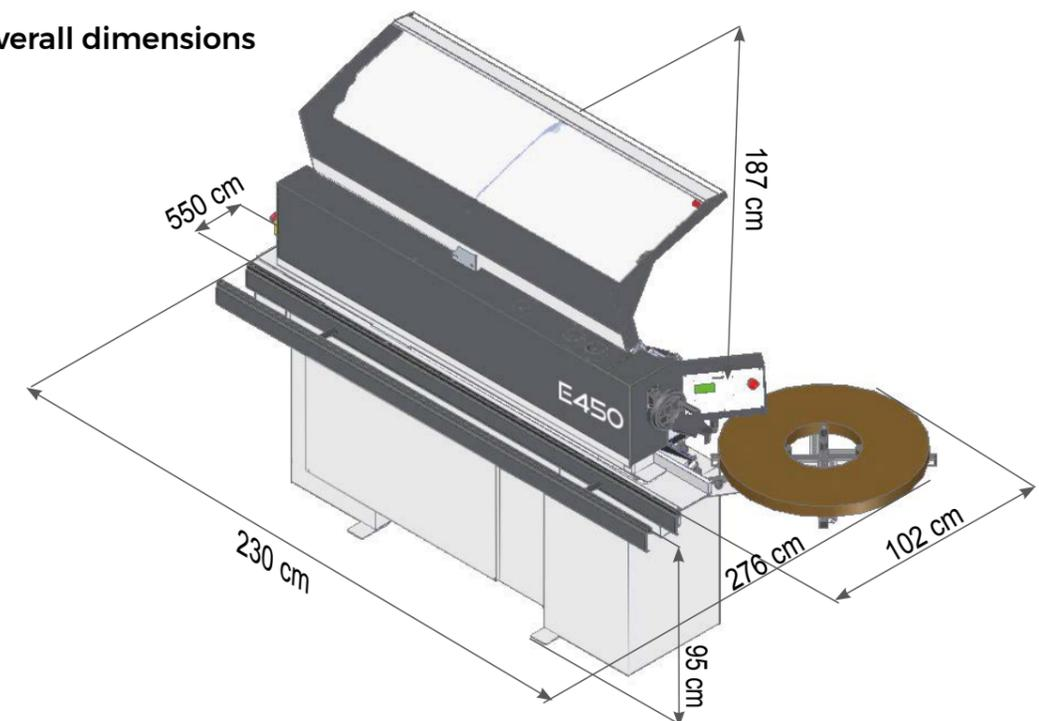

We reserve the right to make technical modifications. The machines illustrated may include fittings and accessories not included on standard machine versions. For photographic purposes, some units are shown without protections. Machines must however always be used with all protections fitted and operative.



— ProWoodTech —

Casadei Industria WOOD S.r.l.
Via Guardia di Rocca, 14
47899 Serravalle
Repubblica di San Marino
Tel. +378 0549 960011
Fax +378 0549 955010
www.casadei-industria.com

THINK COMPACT EDGE EASY