

**barbaric**



# Wood handling



## uniWood lifter series

Our standard lifter series for most commonly used wood board materials. Next to their lightweight and compact build these lifters convince with great ergonomics and maximum safety.

*Ideas that move.*

### Other features

- > Adjustable control handle
- > compact design and low build height
- > Load capacity: max. 250 kg
- > Special operation handle for one-hand operation
- > Hoist: continuously, max. 10 m/min.



Video



**The perfect combination.** As a complete solution, we also offer our lifters together with the matching craneway system or pillar jib crane (page 7).

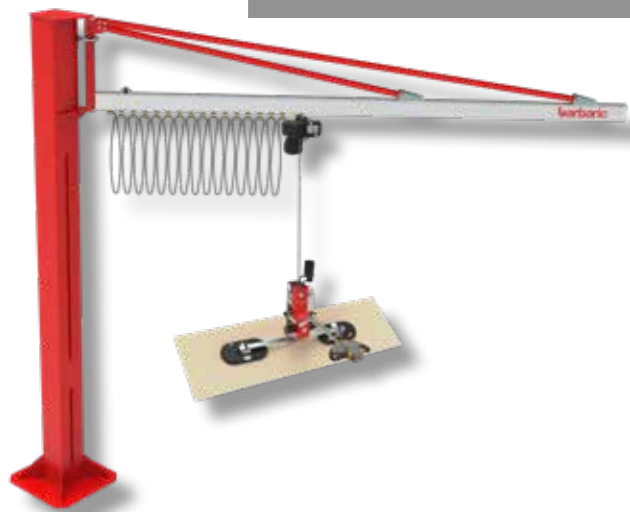

Also available in the version UWL 1 - without tilt function

uniWood UWL 3



uniWOOD

uniWood UWL 3S



uniWOOD

The perfect complement for manipulating plates at the edgebander.

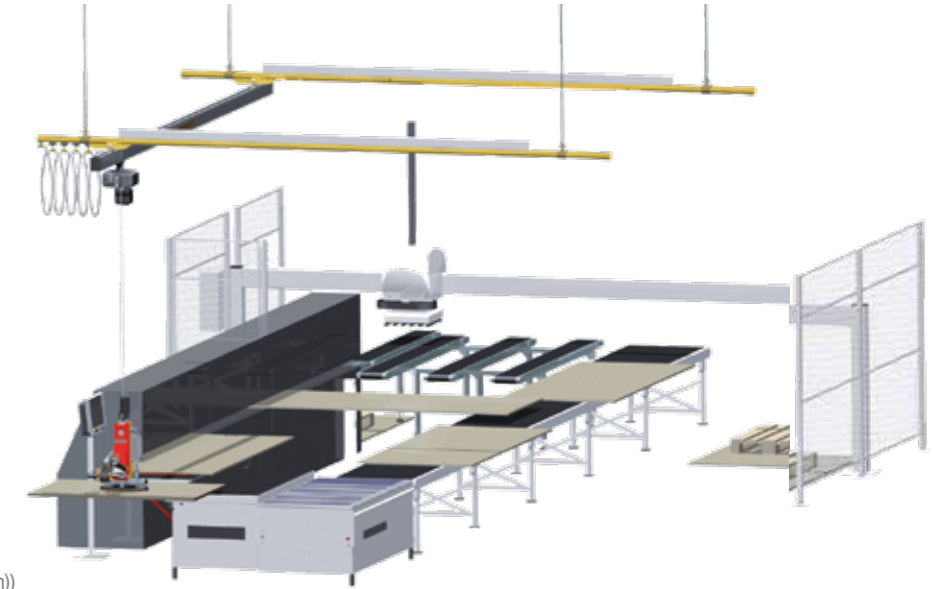
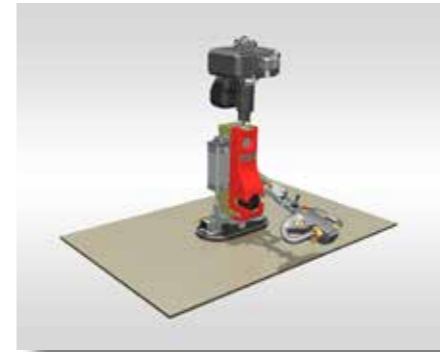

> Version UWL 3S - with tilt function  
(also available in the version UWL 1S (without tilt function))

### Panel handling made easy

With its slim and compact design with low mass the uniWood 3S is ideal for quick handling of plates on all processing machines.

The load suspension with only one suction cup allows the lifting of parts of all sizes. Also structured and glossy surfaces can be gripped easily and without damage. Included is a 90° tilting device for vertical picking up and placement of the parts.

### Universally applicable

With this system, the feeding of edgebanders and stationary panel saws with only one operator is possible. The uniWood 3S is an ideal complement for handling of large special parts that can not be transported by the standard return system.

- > Load capacity: max. 200 kg
- > Special operation handle for handling by one hand
- > Hoist: continuously, max. 10 m/min.



Video

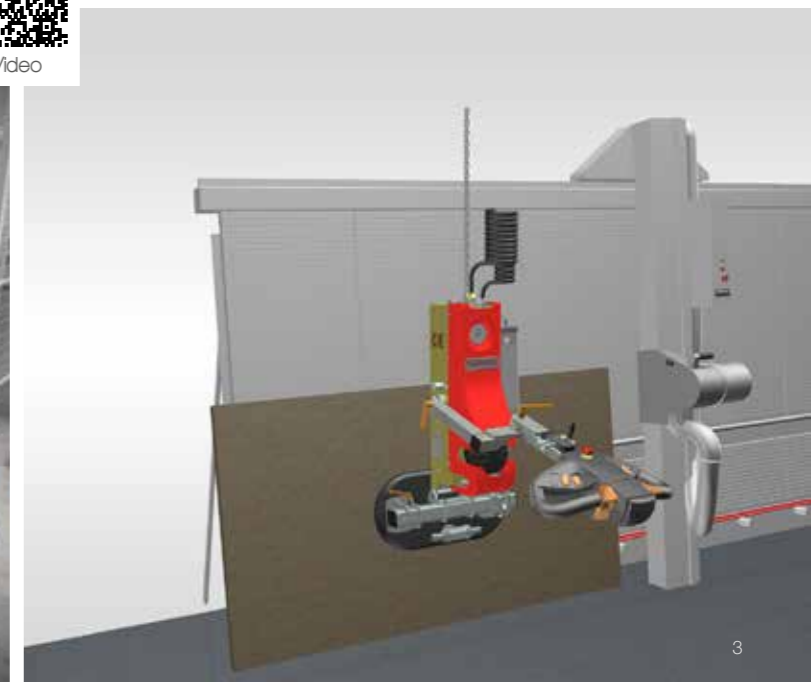

The special handling system with narrow construction for vertical and horizontal transport of doors.

### Characteristics

- > Tilting of parts 180° horizontal
- > Continuously variable tilting speeds
- > Complete handling system with lifting gear
- > One-handed operation through ergonomic handle
- > Continuous and smooth movements
- > Manual adjustment of the center of gravity

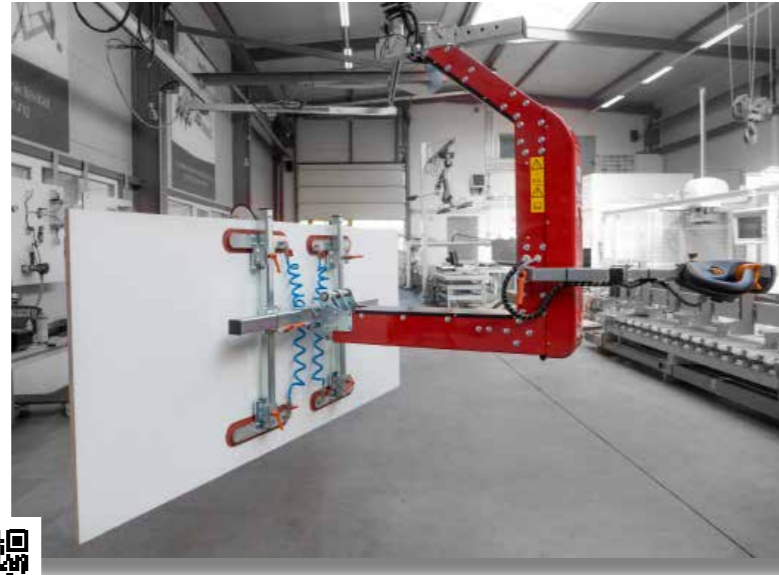

Video



### Technical data

- > Load capacity: 220 kg / 250 kg
- > Tilting speed: approx. 6 sec./90°
- > Size of suction cups: 4x or 6x 377 x 81 mm  
Special versions on request
- > Lifting speed: 0-10 m/min continuously variable through frequency converter
- > Lifting height: approx. 2.0 m
- > Operating voltage: 230 V / 50 Hz

### Special 180° tilting function for part flipping



The ultimate safety innovation for all Barbaric handling systems.



Video

Also available as an **UPGRADE KIT** for existing handling solutions!

An innovative Upgrade for your handling system.



The SafetyKit vastly increases user safety and adds a wide range of other features to the handling system as well.

#### The main advantages at a glance:

- > Eco-Mode (Compressed air saving function)
- > Maximum safety for the operator
- > Pressure and vacuum monitoring
- > Weight sensor for load control
- > Automatic test of suction performance
- > Detailed error reports & statistical analysis
- > Service and maintenance reminders

#### Brand new options for 2020 SafetyKit models:

- > Automatic suction start while approaching the glass
- > Suction cup switch-off and automatic reduction of maximum weight



Product video



**Handling of cut or dried planks.**

The special lifting device for moving whole posts, KVH, sections such as squadrons or rough sawn boards by a server.

Delivery incl. chain hoist or for hooking into an on-site hall crane.

Power supply by supply to the customer's indoor crane (400 V, 3 phases) due to the built-in transformer possible. Thus, no additional cable is necessary. The control can be carried out via a control handle, wired or by radio.



Technical data

- > Load capacity: up to 1500 kg
- > Operating voltage: 230 V / 50 Hz or (400 V / 50 Hz via transformer)
- > Functions are displayed by means of lamps and pressure gauges

Special solutions, for example: Control via customer crane operation and higher working loads on request.



Product info



Combining high performance with ease of use. Our crane systems are specifically designed and built for handling tasks.

Pillar jib crane SSK

Slewing crane systems in lightweight construction for all working loads and arm lengths. On request with enlarged mounting plate.

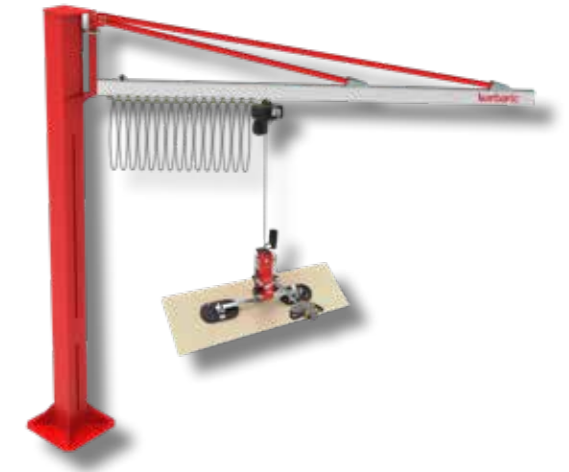

Light craneway system SSY

Our lightweight aluminium crane system for manual operation allows track gauges of up to 8 m. All trolleys with guide rollers on the side.

Bridges with framework construction

2D aluminium framework



3D aluminium framework

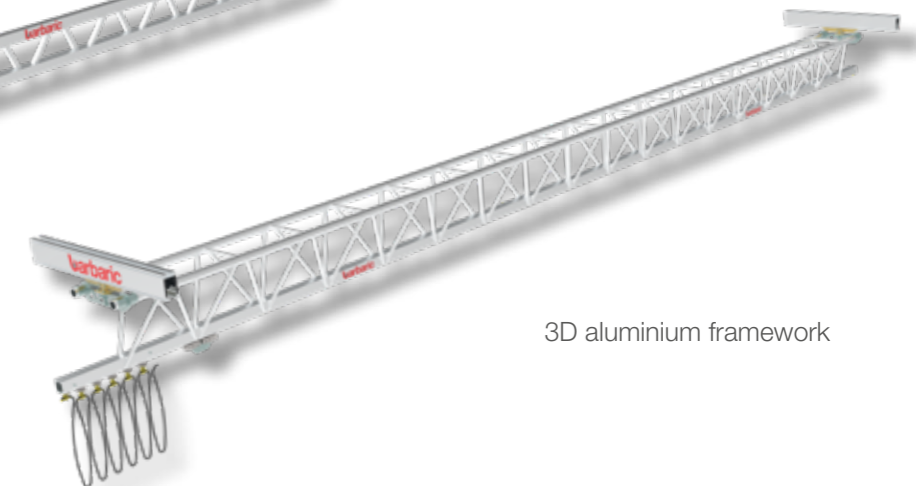

## Storage and retrieval of panels out of a shelf rack on the standing panel saw.

### Design

- > rail system with dual bridge construction
- > lift mast rotating 360°
- > lightweight aluminium profiles as carriage guideways
- > special lifting traverse for panel separation

### Electrical control

All control elements are located in our unique control handle. Separate holds on the framework are used for manipulator guiding and rotating.

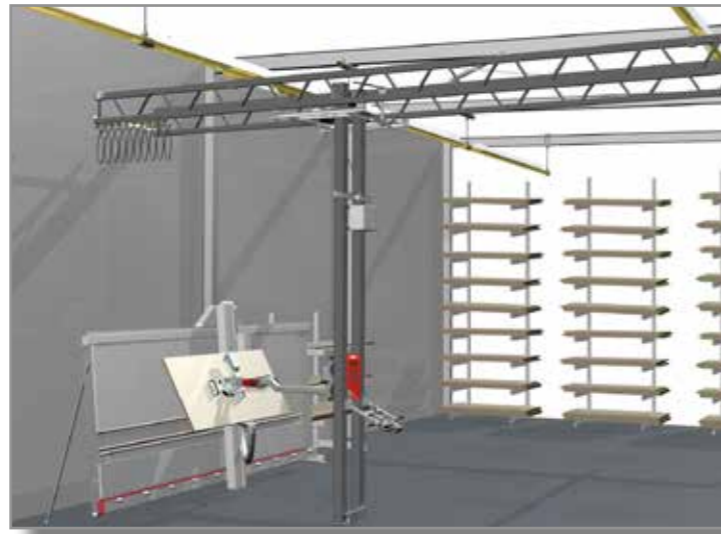

### Security features

The system is equipped with a security unit avoiding unintentional release of the load. Panels only can be released when the weight of the panel is supported by the rack shelf or another plain surface. For additional safety a pressure gauge and an alarm horn are installed on the device.



Video

### Technical data

- > Load capacity: max. 100 kg
- > Lifting speed: max. 10 m/min (continuously variable due to frequency conversion)
- > Vacuum generation: with electrical vacuum pump (25 m³/h)
- > Operating voltage: 230 VAC / 50 Hz
- > Tilting device: 90°
- > Rotating device: 90° (manual rotation)
- > Span: up to 12 m
- > Lifting height: up to 8 m
- > Lifting mast: 360° rotatable, not endless
- > Display on the operating handle - camera mounted on the lifting carriage

### Optional features

- > Increased load capacity to 250 kg
- > Vacuum generation: by ejector (6 bar compressed air required)
- > Endless turning of the lifting mast
- > Electrically driven crane bridge
- > Pneumatic brake for turntable (6 bar compressed air required)
- > Custom made beams
- > Electric turning 90°

## Manipulator for use on all standard pallet trucks and forklifts.

Ideal for large manipulation areas and maximum mobility for handling panels or parts.

Design: Built in batteries for power supply and fork fixation clamps for a strong secure hold.

- > Incl. 90° tilt mechanism
- > 90° manual turning function
- > Load capacity: max. 100 kg
- > Optional: electrical turning 90°
- > Optional: Increased load capacity to max. 250 kg

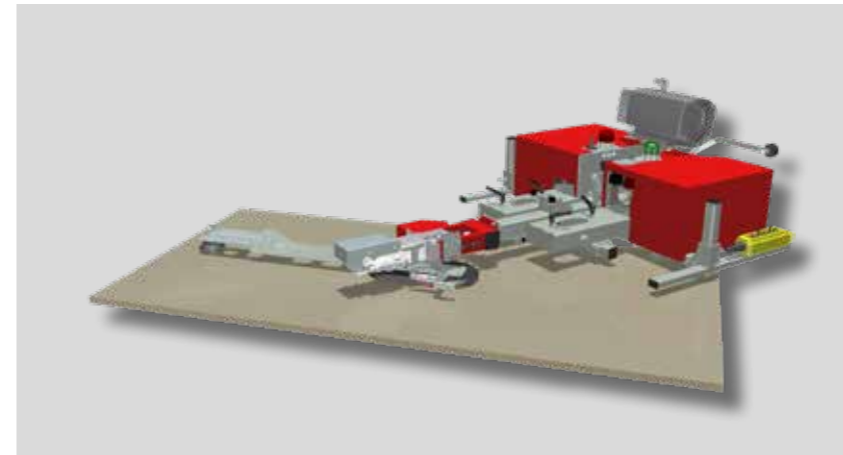

Video

# Special beams and suction traverses

We offer a suitable lifting beam for every application.

## Suction beam for thin boards

Working load 150 kg. With 4 suction cups Ø 270 mm on an adjustable beam (beam size: 1500 x 800 mm) for thin dense boards, PVC, aluminium, metal, melamine. Not suitable for MDF and permeable chipboard panels.

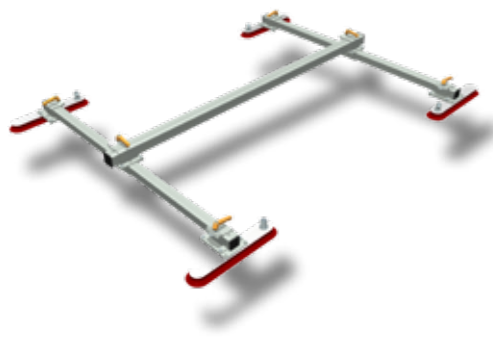
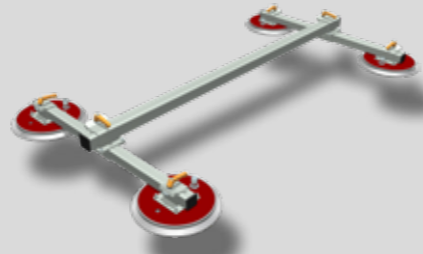

## Cross beam for doors

Working load 150 kg. With 4 oval suction cups 377 x 81 mm on an adjustable beam - Spreader for doors with glass section (beam size 1500 x 1200 mm).

## Cross beam for iron sheets and acrylic glass

Working load 150 kg. With 8 bellow suction cups Ø 115 mm on an adjustable beam - Suction beam with extra length for thin parts. (beam size: 2500 x 1200 mm). The outer suction cups are lockable for lifting of smaller plates.

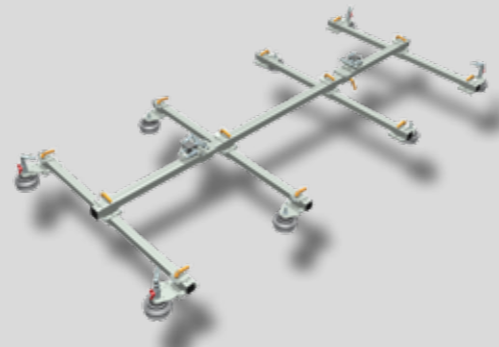

## Service & After-Sales



WE ARE THERE FOR OUR CUSTOMERS - EVEN YEARS AFTER THE SALE.

Quality, efficiency and innovation - three keywords that apply specifically to Barbaric's service competence. The employees of our service hotline have been with us for many years and

have excellent knowledge of our products. They will be happy to help you - no matter whether it is a spare part, maintenance or service request.

### SERVICE -HOTLINE

Phone: +43 732 779800-300

Email: [service@barbaric.at](mailto:service@barbaric.at)

Mo – Fr 07:00 – 16:00

### SPARE PARTS -HOTLINE

Phone: +43 732 779800-400

Email: [spareparts@barbaric.at](mailto:spareparts@barbaric.at)

Mo – Th 07:00 – 16:00

Fr 07:00 – 12:00

# Barbaric - your competent partner for any vacuum handling application



At Barbaric, our goal is to provide optimal solutions for every handling application. In addition to our automatic handling solutions in the field of panel and parts handling for commercial or industrial production lines, we also develop manual vacuum lifters for all remaining manual lifting processes.

### Automatic panel and part handling

Our intelligent solutions are used by many customers around the globe.

- > Panel storage systems
- > Feeding systems
- > Buffer storage
- > Return systems

are just a few examples of modern systems in the field of material handling. Each system in this area is built individually according to our customers' requirements, while existing components and proven concepts are used.

### Manual handling solutions

For customers in the wood, glass industry or for construction site use, we offer the suitable lifting equipment.

Barbaric provides optimal handling solutions for safe and ergonomic lifting applications.

Manual vacuum lifters from Barbaric enable efficient handling of heavy panels or glass and save valuable time in production. Heavy lifting tasks can be performed effortlessly by just one operator. By purchasing suitable handling solutions, sickness-related absences can be minimized and attractive jobs created for the employees.

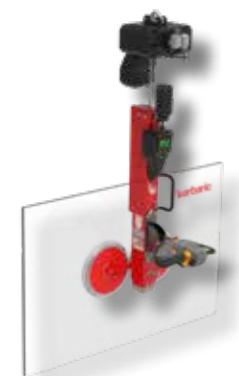



## Headquarters

**Barbaric GmbH**  
Pummererstr. 12  
4020 Linz, Austria  
Phone: +43 732 779800  
e-mail: office@barbaric.at

## Production facility

**Barbaric GmbH**  
Lichtenberger Str. 37  
4201 Eidenberg, Austria

## Sales locations & subsidiaries



**Barbaric GmbH Germany**  
Lammgasse 7  
75382 Althengstett, Germany  
Phone: +43 732 779800  
email: office@barbaric.at



**Barbaric North America Inc.**  
301 Kitty Hawk Drive  
US-27560 Morrisville  
Phone: +19194252803  
email: info@barbaric.us

[www.barbaric.at](http://www.barbaric.at)



Image video